

Sustainable

Durable

Luxurious

Innovative

FUSED BAMBOO FOR EXTERIOR USE

DECKING / CLADDING / SOFFIT / FENCE / LUMBER & PANEL



dasso · bamboo



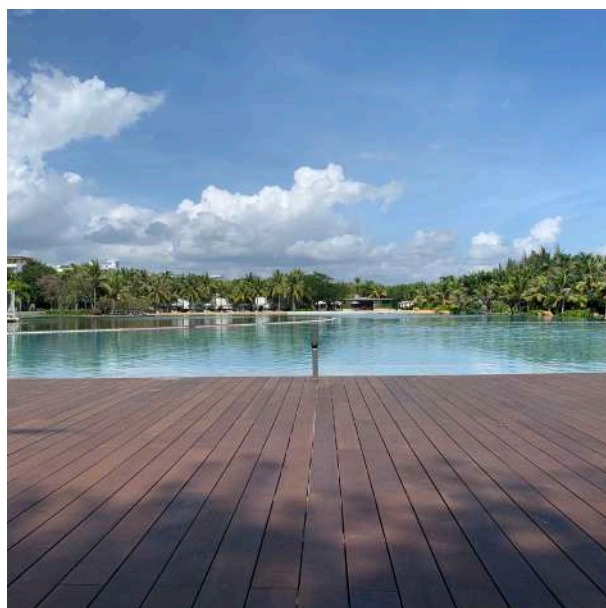

CONTENT

<i>dasso Brand</i>	04
<i>Fused Bamboo</i>	08
<i>Decking</i>	14
<i>Cladding</i>	16
<i>Soffit</i>	18
<i>Lumber & Panel</i>	20
<i>Project</i>	24



dasso group, founded in 1993, is one of the global leader and innovator of the bamboo industry. After decades of development, dasso now have 8 manufacturing facilities and over 1000 employees.

dasso has always pursued the advanced crafts, technology and automated manufacturing equipments; we aimed to united the talented people to develop the efficient management system for production and quality control, which enable dasso to provide the bamboo products with superior quality and become powerful integrated solution provider for bamboo products. dasso offers dassoFLOORING, dassoELEMENTS, dassoXTR, and dassoCTECH as regular product range.

In addition to conventional products, dasso group cooperates with design institutes and developers in order to provide customized products, such as bamboo fire-resistant ceiling of Madrid International Airport; Bamboo acoustic material of Wuxi Grand Theater; special bamboo elements in Culture and Art Center of Fuzhou Strait ... until now, we have completed more than 1,000 projects in more than 60 countries all over the world.





Hangzhou Dasuo Technology Co.,Ltd

Multi-purpose production facility produces 500,000 m² per year.



Hangzhou Zhuangyi Furniture Co.,Ltd

Furnishing Plant 400 x 40 FCL container per year.



Fujian Dasso Industry Co., Ltd

dassoXTR & dassoCTECH production facilities produces 2 million m² per year.



Zhejiang Daocheng Bamboo Industry Co., Ltd

An overseas sales team of dasso bamboo products, whose business is around the world with more than 50 staffs.



Jiangxi Zhushang Bamboo Industrial Co.,Ltd

dassoXTR production facility produces 1 million m² per year.



Zhujia Gallery

Integrated design, development, sales and promotion of green bamboo, original design of bamboo crafts.



Zhejiang Xinhaiye Bamboo Technology Co.,Ltd

dassoXTR production facility produces 500,000 m² per year.



Shunchang Zhujia Bamboo Industrial Co.,Ltd

Multi-purpose production facility produces 200,000 m² per year.

- *Fused Bamboo over 13,000,000 M² has been installed all over the world*
- *Next Generation of Hardwood for Exterior Use*
- *From Natural to Natural*





Fused Bamboo for Exterior Use

Through its patented "heat treatment" technology, dasso processes fused bamboo into dassoXTR for exterior use in classic "Espresso" color; With the application of Ceramix Technology, dassoCTECH exterior materials have wonderful performance outdoor while retaining the original color - Cognac. Both dassoXTR and dassoCTECH can be processed into decking, cladding, soffit, fence, lumber and panel, which are widely used in commercial and residential projects.



Decking

*Reversible face
Structural T&G end match*



Cladding

*Simple, easy hidden fastener system
Modular T&G end match installation*



Soffit

*Easy hidden fastener system
Structural T&G end match*



Lumber and Panels

*Wide range of usage
Flexible for customized production*



Technology Principle

dassoXTR



dassoXTR patented fusion process extracts the sugars and starches from the bamboo fibers and replaces it with phenolic resins. Then the impregnated fibers are compressed to create a very hard, dense and durable Fused Bamboo that prevents bacteria, fungus and other micro-organisms from attacking dassoXTR.

dassoCTECH

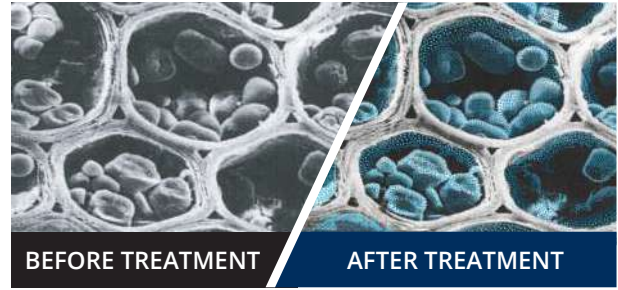

dassoCTECH is crystalized the fibers with CeramiX particles, impregnated it with phenolic resin(the same resin found in bowling balls),then compressed to form Fused Bamboo. Because Fused Bamboo is now fully impregnated with CeramiX particles that crystalizes the nutrients from attracting bacteria, fungus, molds or insects, the fibers does not rot under exposed environments.

Fused Bamboo vs Other Exterior Materials

Competitive Material	dassoCTECH	dassoXTR	Ipe	Balau(Bangkirai)	Teak	Meranti Batu	Western Red Cedar
Density	1,200	1,100	1,060	850	655	480	340
Stiffness MOE	16,700	19,100	22,070	16,950	11,280	11,390	7,660
Janka Hardness(N)	17,659	16,992	15,620	7,120	4,740	2,460	1,560
Durability(Class)	1	1	1-2	2	1-3	3-4	2

** dasso products data from Third-party Testing Institutions & Wood Research Data from Website*

The Feature of Fused Bamboo



Environment Friendly

Ready for harvest after 4-6 years [compared to up to 100 years for hardwood species]-no deforestation



Mould Resistance

Class 0 [DIN EN ISO 846: 1997-10] [DIN EN 152: 2011]



Fire Resistance

Class A:ASTM E84 -12 Bfl-s1:EN13501-1 BAL 29:AS 1530.8.1-2007



Termite Resistance

Reticulitermes santonensis DC D(durable) [EN 117] Class 1:AS 5604 (2005)



Hard & Durable

Brinell > 79.2N/mm² [EN1534] Durability: Class 1 [CEN/TS 15083-1: 2005][EN 350: 2016]



Warranty

Applicable Residential and Commercial Warranty

The Process of Fused Bamboo



Decking



Cladding



Soffit



Lumber & Panel

Technology Patented

dasso is the owner of fused bamboo processing technology and patent, and has been protected by technology patent in many countries.



Europe
2269788

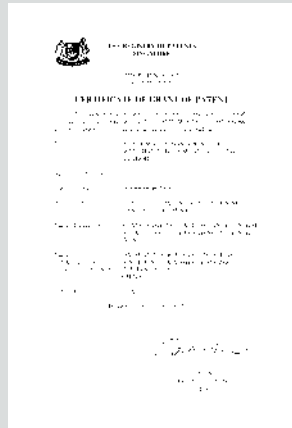

Singapore
SG165525



United States
US870958B2

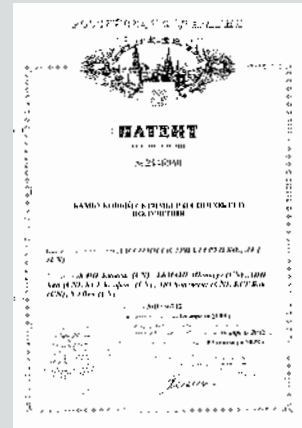

Russia
RU2446940C1



Malaysia
PI2010004676



China
ZL200810093764.4



Australia
2008355033.0



DECKING



dassoXTR



dassoCTECH



dassoXTR & dassoCTECH Decking are the superior choice for all exterior decking applications and has been used worldwide in many commercial and residential projects. Only two decking profiles are needed for your exterior decking application. A single grooved (G1) plank used as starter and ending plank and the G2 for the deck itself. All our deck planks also include our exclusive tongue & grooved end matched system to attach the planks seamlessly together.

Feature

 End Matched	 Reversible Faces	 2-Side Grooved	 Hard & Durable
 Fire Resistance	 Stable & Precise	 Termite Resistance	 Mould Resistance

Specification

dassoXTR Decking	dassoCTECH Decking	Size (mm)	dassoXTR Decking	dassoCTECH Decking	Size (mm)
XD20-SG2-5TG-PSR	ED20-SG2-5TG-PSR	T20 * W137 * L1850	XD20-MG2-5TG-PSR	ED20-MG2-5TG-PSR	T20 * W155 * L1850
XD20-SG1-5TG-PSR	ED20-SG1-5TG-PSR	T20 * W137 * L1850	XD20-WG2-5TG-PSR	ED20-WG2-5TG-PSR	T20 * W178 * L1850
XD20-SG2-5TG-PSV	ED20-SG2-5TG-PSV	T20 * W137 * L1850	/	ELD20-SG2-PSR/V	T20 * W137 * L3050
XD18-SG2-5TG-PSR	ED18-SG2-5TG-PSR	T18 * W137 * L1850	/	ELD20-MG2-PSR/V	T20 * W155 * L3050
XDUG20-SG2-5TG-PSR	/	T20 * W137 * L1850	XD40-SG0-5TG-PSR-L0	ED40-SG0-5TG-PSR-L0	T40 * W137 * L1829

Installation

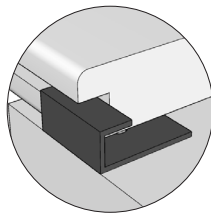
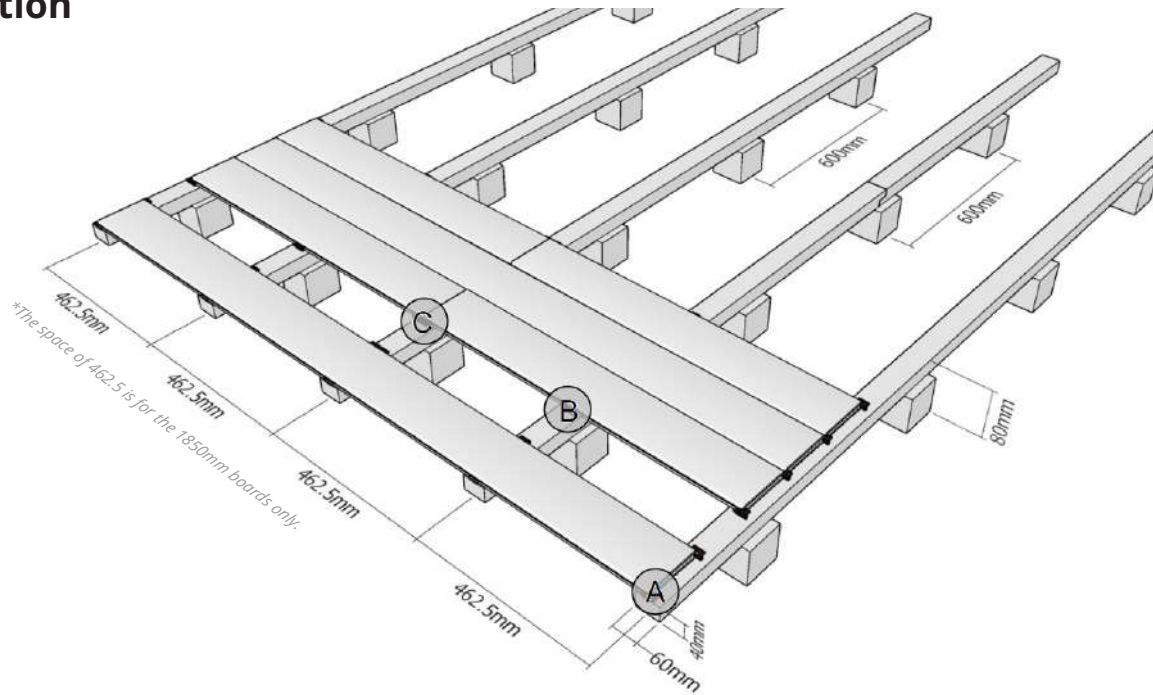

A



B

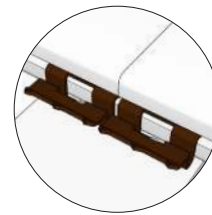

C

Option1: Clip Installation

Step 1. Determine the surface side of the boards (reeded or flat surface).

Step 2. Use fasteners or other suitable fasteners in the following sequence.

Step 3. Press fastener in the groove of one decking board.

Step 4. Tighten the screw in the fastener and the sub beam.

Step 5. Use approx. 20/17/14 fasteners per m², this is depending on the type or board 137/155/178mm wide. When the tongue and groove are connected on the sub beam use 2 fasteners, 1 for every board.

Step 6. Only use the included stainless steel decking screws (4.2x30mm).

Option2: Screw down installation

Step 1. Determine the surface side of the boards (reeded or flat surface).

Pre-drill the screw holes 20mm from the side of the board. Be sure to pre-drill with a large enough drill to avoid cracking of the decking.

Step 2. Always screw both sides (left and right) of the board.

Step 3. Use stainless steel decking screws (5x50mm).

Installation Accessories

	Clips Code	Size	Photos	Screw	Screw Code	Size	Photos
	Clips	H-Clips (DC-08A)	27x22x11			DS-01	4.2x30
S-Clips (DC-07) (Decking=18mm)		30x25x10		DS-02	4.2x25		
S-Clips (DC-06) (Decking=20mm)		30x25x11		DS-03	4x41		

CLADDING



dassoXTR



dassoCTECH



dassoXTR & dassoCTECH Cladding is the great choice in commercial exterior siding, where it ages naturally like wood. Our unique sheathing system with FasTrak offers the most appealing looking rain screen and cladding siding solution available. It reduces wastage and speeds up installation by 50%.

Feature

-  End Matched
-  Match Installation
-  SHIPLAP
-  Hard & Durable
-  Fire Resistance
-  Stable & Precise
-  Termite Resistance
-  Mould Resistance

Specification

dassoXTR Cladding	dassoCTECH Cladding	Size (mm)	dassoXTR Cladding	dassoCTECH Cladding	Size (mm)
XS18-SSL-5TG-PSS	ES18-SSL-5TG-PSS	T18 * W137 * L1850	XS12-100G2-PSS	ES12-100G2-PSS	T12 * W100 * L1860
XS18-SSL-5TG-PSS-L0	ES18-SSL-5TG-PSS-L0	T18 * W137 * L1829	XS18-WSL-5TG-PSS-L0	ES18-WSL-5TG-PSS-L0	T18 * W178 * L1829

Installation

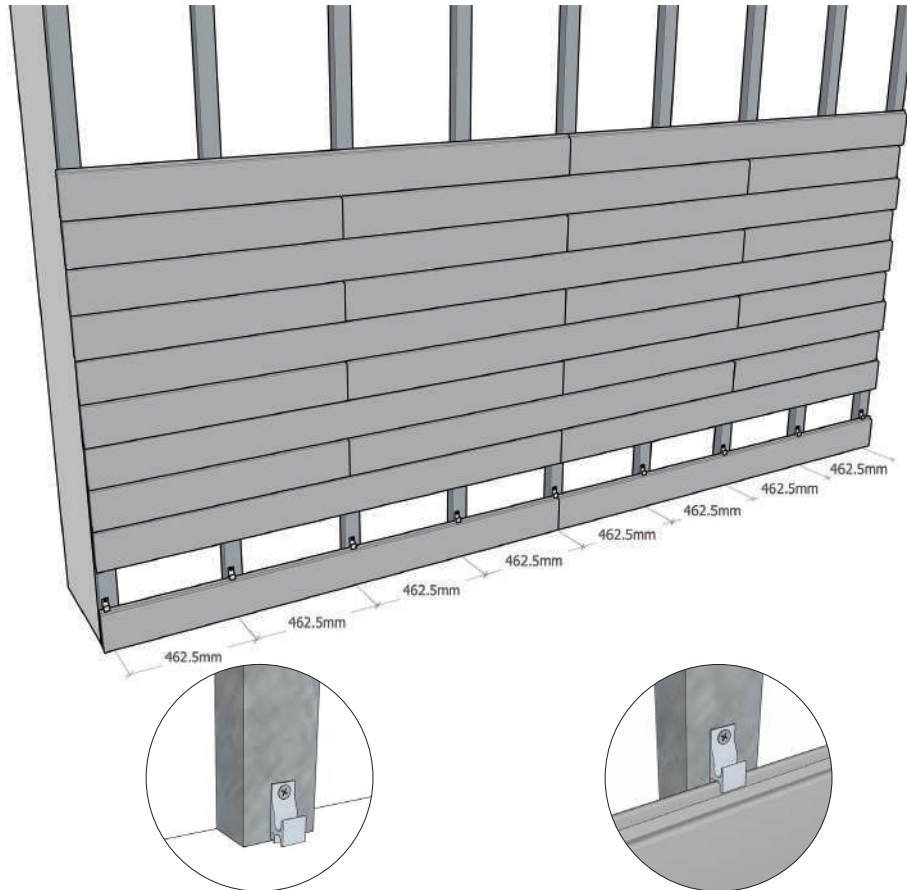

First Row

Second Row

Step 1. Levelling first row of fasteners.

- Start with the lowest row of fasteners and make sure they are placed fully level (using a spirit level).

Step 2. Install first row of boards.

-Holding the first boards level, slide the lip of the groove on the lower edge behind the tabs on the fasteners.

-Make sure that the fasteners engage deeply enough in the groove so that the boards lay level. Tapping the boards should be done carefully, preferably with a rubber mallet.

-We advise always fixing the end (end joints) of the boards on a batten/ beam, using 2 fasteners.

Step 3. Second row of fasteners

-Install the second row of fasteners, pushing them down on the top edge of the first row of boards.

Step 4. Install second row of boards.

Step 5. Continue with the rest.

-Continue to install the cladding boards in this way to cover the full surface. Make sure you keep the fasteners level and make sure enough ventilation space (5-10 mm) is kept on the edge.

Installation Accessories

	Clips Code	Size	Photos		Screw Code	Size	Photos
	Clips	Clip [CC-18]	42x19x15			Screw	CS-01
Clip [CC-12]		40x24.5x7.5		DS-01	4.2x30		
				DS-02	4.2x25		
				DS-03	4x41		

SOFFIT



dassoXTR



dassoCTECH



dassoXTR & dassoCTECH Soffit, Deck Skirting and Wainscoting are Pre-primed and specifically designed for interior and exterior use with no leaching and zero VOC. All Fused Bamboo are Bfl-S1 rated. dassoCTECH soffit, deck skirting and wainscoting are ideal for creating an elegance lasting beauty environment.

Feature

-  End Matched
-  Match Installation
-  SHIPLAP
-  Hard & Durable
-  Fire Resistance
-  Stable & Precise
-  Termite Resistance
-  Mould Resistance

Specification

dassoXTR Soffit	dassoCTECH Soffit	Size (mm)
XS012-100-5TG-PSS	ES012-100-5TG-PSS	T12 * W100 * L1850
XS012-100-5TG-PSS-L0	ES012-100-5TG-PSS-L0	T12 * W100 * L1829

Installation

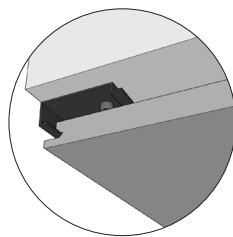
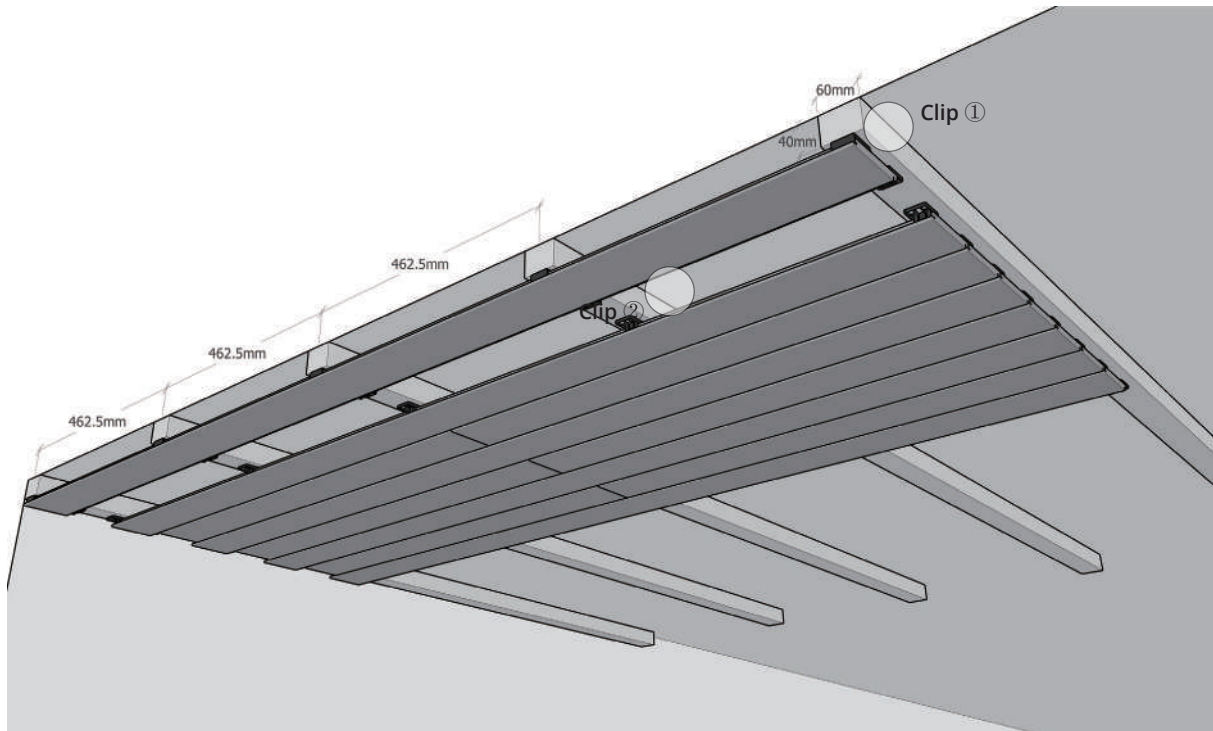

Clip ①



Clip ②

Step 1: Make sure the soffit is the surface. Use the soffit clip.

Step 2: Use the starter clip ① for the first board, Use 1 screw per starter clip.

Step 3: Use the soffit clip ② to install the following soffit boards, screw down the nail to contact the joint and clips, use 2 screws per field clip for soffit.

Step 4: Use approx. 27 fasteners per m2, each joint should use the clips.

Step 5: For applications exposed to salt air, near large bodies of water, swimming pools or other areas where corrosion is more likely to occur, always use Grade 316 stainless steel screws.

Installation Accessories

	Clips Code	Size	Photos		Screw Code	Size	Photos
Clips	Clip SOF-1	32x32x10.8		Screw	SS-01	4.2x28	
	Clip SOF-2	32x25x12			SS-02	4.2x28	

LUMBER&PANEL&FENCE



dassoXTR



dassoCTECH



dassoXTR & dassoCTECH Lumber and Panels are to be considered like unfinished lumber; it is S2S+RE2 (sides need to be planed). The material is not pre-primed so the user can finish it as they choose. Both lumbars and panels come oversized to trim in two different thickness: 20mm and 40mm. dassoXTR & dassoCTECH bamboo panels are ideal for creating outdoor furnishings for years of lasting beauty. dassoXTR & dassoCTECH Fence is Pre-primed and specifically designed for gallery frame, Pergola barrier, outdoor furnishings, signs and so on.

Feature

-  **Hard & Durable**
-  **Fire Resistance**
-  **Stable & Precise**
-  **Termite Resistance**
-  **Mould Resistance**
-  **Wide range of usage**
-  **Flexible for customized production**

Specification

dassoXTR Lumber	dassoCTECH Lumber	Size(mm)	dassoXTR Lumber	dassoCTECH Lumber	Size(mm)
XF30-65-6FT-PSS	EF30-65-6FT-PSS	T30 * W65 * L1860	/	EL20-307-6FT-UAC	T20 * W307 * L1860
XF30-100-6FT-PSS	EF30-100-6FT-PSS	T30 * W100 * L1860	/	EL40-307-6FT-UAC	T40 * W307 * L1860
XL20-205-6FT-UAC	EL20-205-6FT-PAC	T20 * W205 * L1860	/	ELF20-65/100-PSS	T20 * W65/100 * L3050
XL40-152-6FT-UAC	EL40-152-6FT-PAC	T40 * W152 * L1860	/	ELF20-137/155-PSS	T20 * W137/155 * L3050
XP20-625-6FT-UAC	/	T20 * W625 * L1860	/	ELF30-65/100-PSS	T30 * W65/100 * L3050
XP40-625-6FT-UAC	/	T40 * W625 * L1860	/	ELF30-137/155-PSS	T30 * W137/155 * L3050

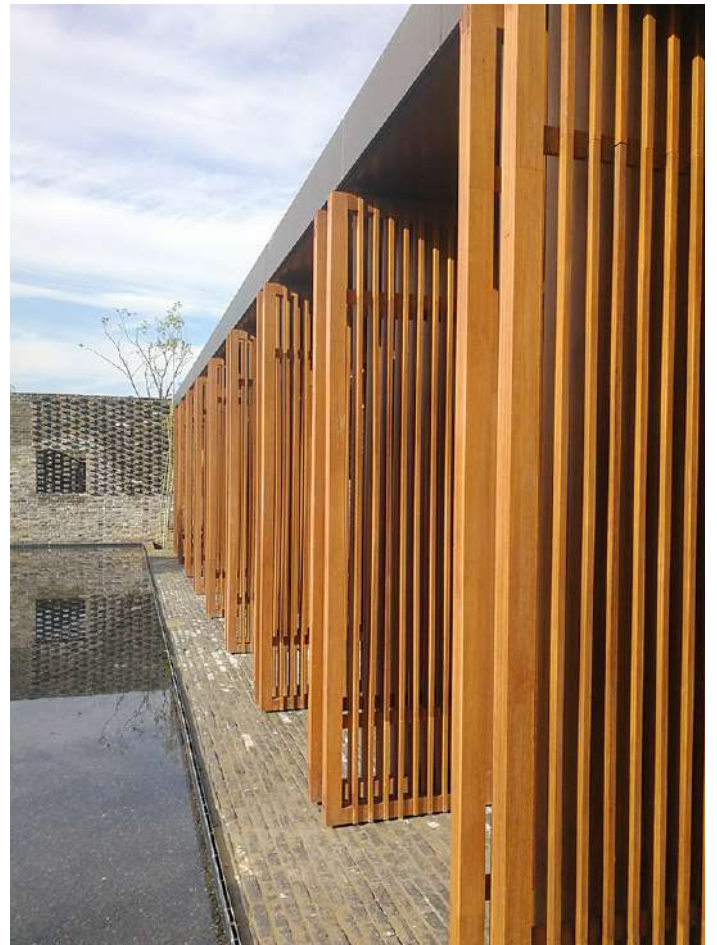

Color Fading & Maintenance

Fused Bamboo (dassoXTR and dassoCTECH) are natural product, its appearance may vary in grains and colors. When exposed under the natural sunlight over time, the appearance and color may change depending on the extent of UV light exposed to the material. The XTR boards originally have a dark brown color and the CTECH in Cognac, both will lighten up over several weeks or months. The board's color without regular maintenance will eventually grey out to a nice silver patina just like any hardwood exposed to sunlight. If a brown color is preferred, maintenance should be done with an exterior penetrating oil. Stains could be added to the penetrating oil to achieve a desired color of the finish product. Maintenance Instruction is available on dassoGroup.com



Normal Phenomena

Checks and cracks on the surface and on the ends of the boards can arise from the different drying characteristics of the surface and cross-cut ends. This does not affect the structural soundness of the boards.

Project Reference - Tourism College of Zhejiang (Qiandao Lake Campus)



Installed in 2013



Revisited in 2019

WARRANTY

dassoXTR and dassoCTECH offers a 25 years residential and commercial application limited warranty against material defects in workmanship and warrant that the material will not suffer structural damage due to rot, decay, or termites for that period of time, as long as it has been installed and maintained according to our guidelines.

SCOPE

- *The outdoor board is a natural forest product, which varies in color, grain and appearance. Color changes over time depending on the maintenance schedule. Color change can not be a reason to make a claim.*
- *This warranty does not cover damage caused by misuse, accidents, insect infestation, force majeure and damage caused by other, in normal residential unusual, circumstances.*
- *Also not covered are purely visual impairments such as imprints, joints, discoloration by light, seasonal climate-related deformation or wear of the surface coating. Damage resulting from improper installation, maintenance, cleaning or maintenance of the surface coating, mechanical or chemical damage are also excluded from this warranty.*
- *This warranty statement supersedes all previous statements; the granting of the manufacturer's warranty applies only to the current version.*
- *Cracks on the surface and on the end of the boards can arise from the different drying characteristics of the surface and cross cut ends. This phenomenon is normal for most wood species and can not be a reason to make a claim.*
- *The surface sides of the boards will get rougher and will splinter over time as a result of constant shrink and swell of the boards due to dry and wet climate periods. This phenomenon is normal for most wood species and can not be a reason to make a claim.*
- *Dimensional change or cupping of the boards can occur after installation. This phenomenon is normal for most wood species and can not be a reason to make a claim.*
- *The guarantee extends to A-grade products only.*
- *The guarantee applies only to the original purchaser.*

Warranty Conditions

To be able to make use of the warranty the decking must be installed according to the installation instructions. Please read our installation instructions carefully, before installing the floor. No claims can be accepted in case of improper installation!

- *This warranty applies in addition to the normal legal rights of the buyer, including the rights of the buyer against the seller.*
- *If a claim is granted before installing the material, faulty planks are replaced free of charge. No claims can be accepted after installing the material if the buyer could have detected the defects before installation. This warranty does not cover damage that was caused by Third parties (eg transport damage).*
- *If defects occur after installation, dasso reserves the right to either repair the defect or to offer material free of charge to the buyer. If the defective product is no longer in the product range, an equivalent from the current range will be supplied.*
- *A claim does not lead to an extension of the warranty period.*
- *The cost for the replacement of material and other charges are not included in the warranty*

Settlement of the guarantee

The claim must be made in writing, within 30 days, to the dasso dealer/seller, a dasso subsidiary or directly to dasso headquarter.

Dasso reserves the right to check the claimed damage.



Private house in Germany



Marino Cre... pore



Private villa in Phnom Penh / Cambodia

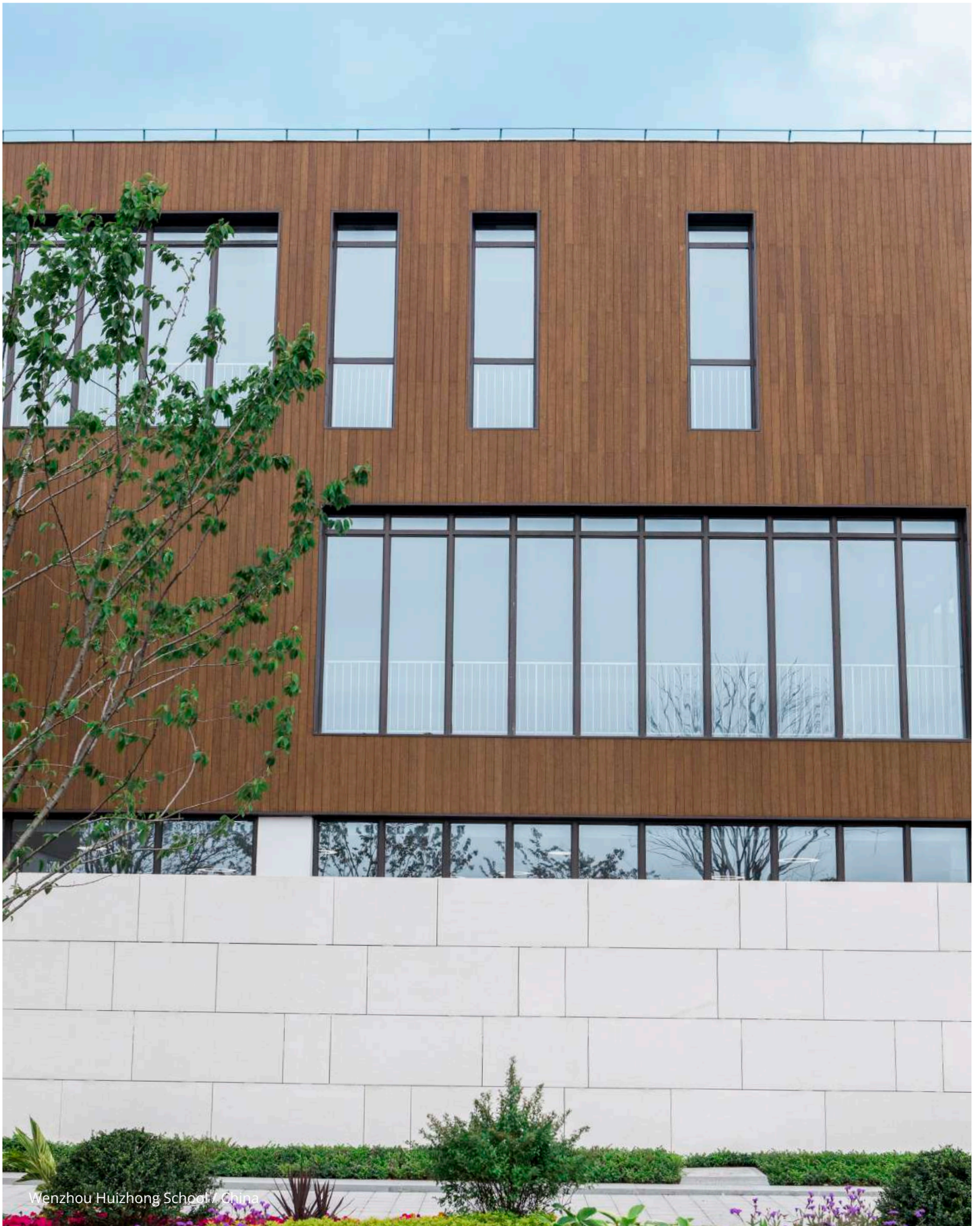

Wenzhou Huizhong School / China



Olmos Park TX / USA



Guangzhou China Overseas Property Xueshill / China



Atlantis Sanya Hainan / China



NanXun Urban Planning Exhibition Center Zhejiang / China

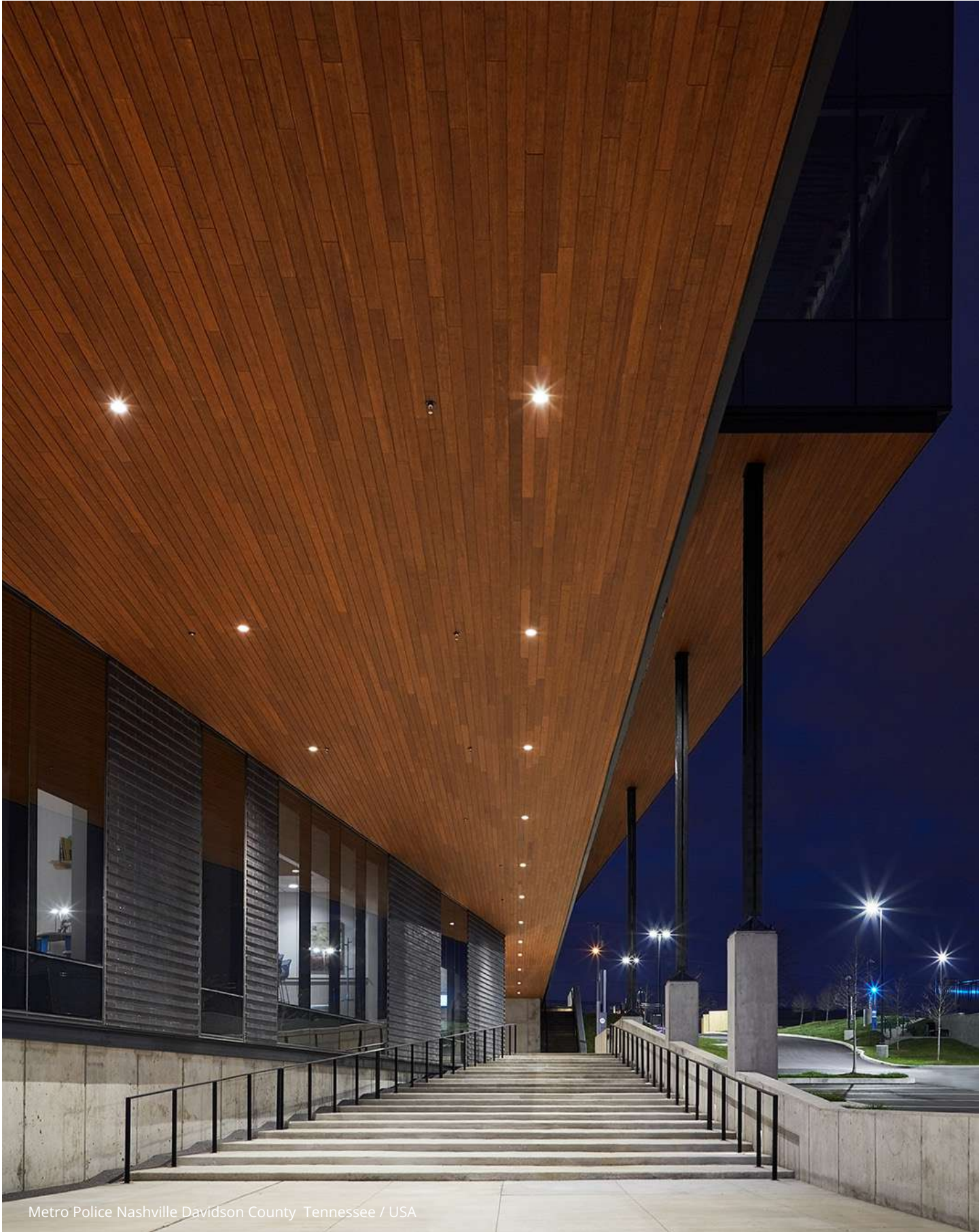

Metro Police Nashville Davidson County Tennessee / USA



Changchun Culture of Water Ecology Park / China



Tsingpu Yangzhou Retreat / China

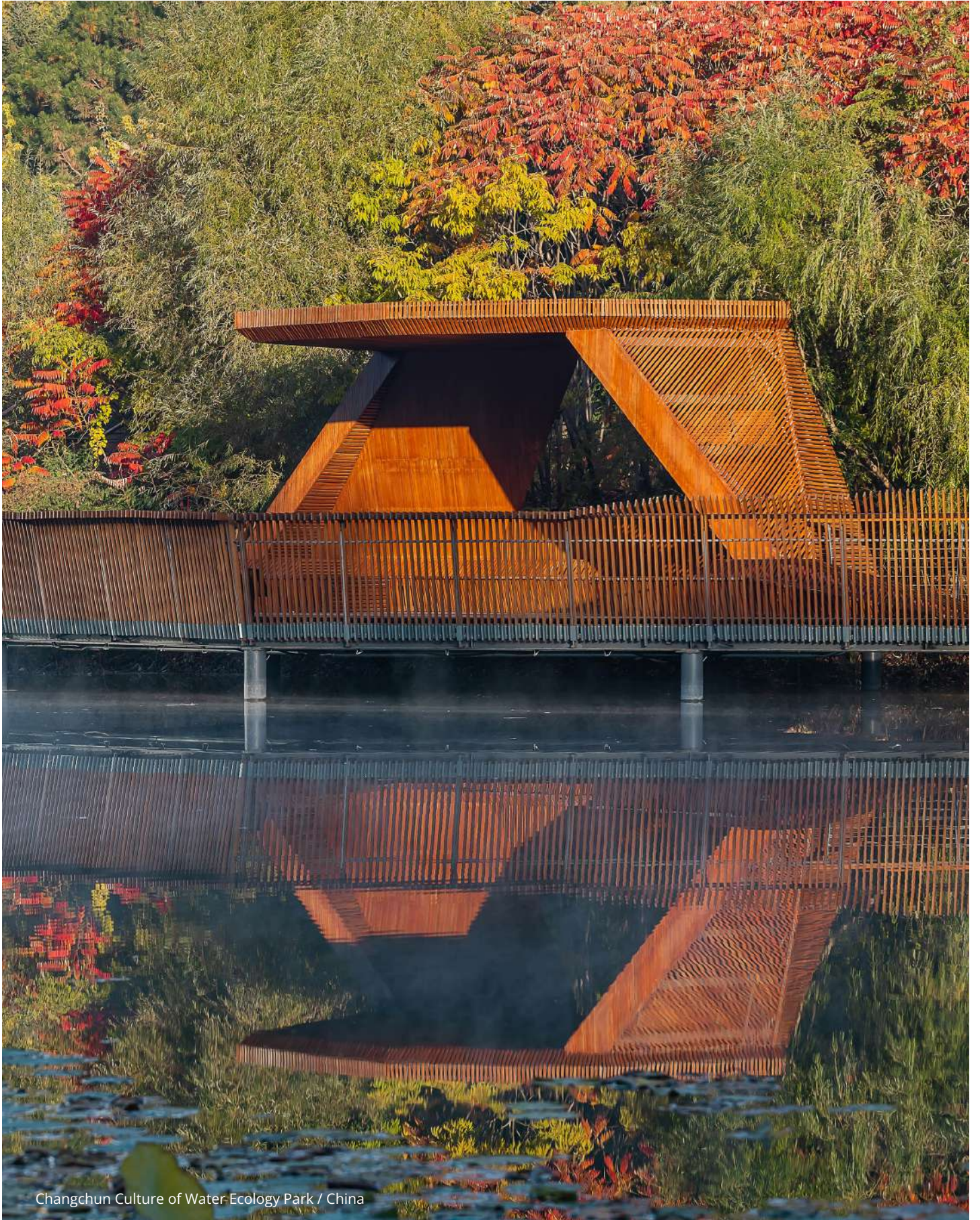

Changchun Culture of Water Ecology Park / China



Novartis Shanghai Campus Office



Vanke Metropolis in China



Qiandao Lake Pearl Square



Urbano Absolute Sathon in Thailand



Atlantis Sanya



Private Courtyard in Germany



The Future Forest of Guangzhou Vanke



Wuxi Yangshan Geological Museum



Private Villa in Lithuania



HongKong-Zhuhai-Macao Bridge



Private Villa in Morocco



Amata Garden Resort Bagan in Burma



Tsingpu Yangzhou Retreat



Fifth Park of Shanghai Vanke Blue Mountain



Xiaoqing Riverbank in China



Private House In Germany



Private house in Surabaya



Kunming Innhouse



Metro Police Nashville Davidson County in USA



Healtdeva Village in Taiwan



Residential House in Australia



Wenzhou Huizhong School



Jindi · Heyue Chunxiao in China



Yitong River Landscape



dasso China

Add: Tongyi, Linpu, Xiaoshan, Hangzhou, China 311251

Tel: 86.0571.5716.3765

Fax: 86.0571.5716.3700

Email: info@dassoGroup.com

Web: www.dassoGroup.com

dasso USA

Add: 6060 Boat Rock Blvd, Suite 800, Atlanta, GA 30336

Tel: 1.404.691.6872

Fax: 1.404.691.6870

Email: info@dassousa.com

Web: dassoxt.com